

INSTRUCTIONS

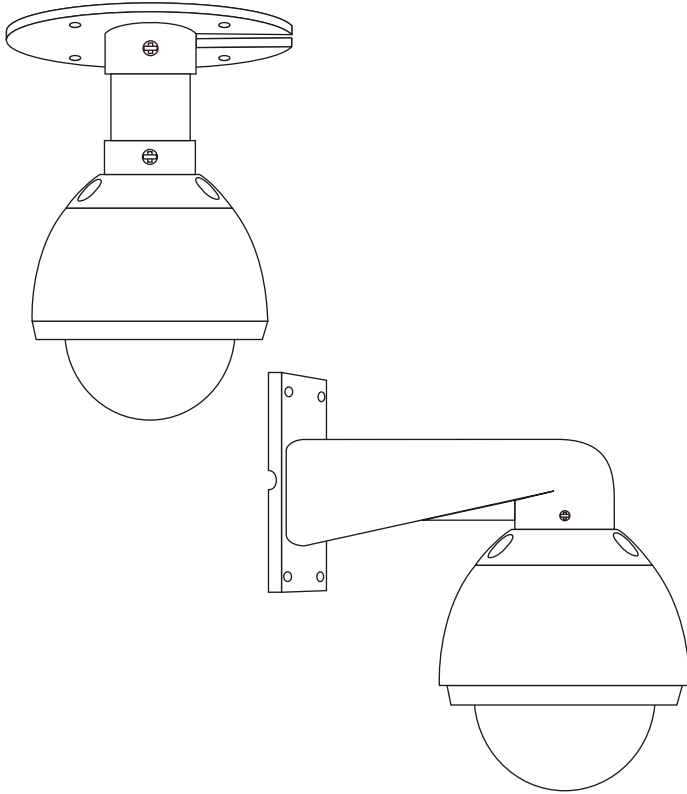

6144

Indoor PTZ Dome Camera with Fan

6154

Outdoor PTZ Dome Camera with Fan & Heater

The **6144** (Indoor) and **6154** (Outdoor) high-resolution Pan Tilt Zoom Color Dome Cameras are perfect for high-end surveillance systems. Their built-in multi-protocol decoders allow the cameras to be controlled using either Pelco D or Pelco P protocols. Built-in heating elements and cooling fans ensure continued operation even when under extreme ambient conditions.

Features:

- High quality color CCD image sensor
- 500 TV lines of resolution
- Built-in multi-protocol decoder: Pelco P or Pelco D
- Up to 256 selectable camera IDs
- 360° Pan rotation and 90° Tilt movement
- Non-volatile memory retains settings during power loss
- Built-in heating elements(6154 only) and cooling fans

Pan Tilt Zoom Dome Cameras Include:

6154 Camera

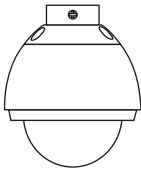

6144 Camera

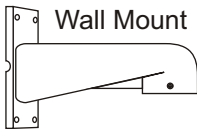
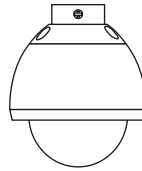

Wall Mount

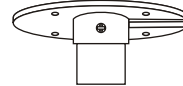

Pendant Mount

Accessories:

Power Supply



Camera Pigtail



Accessory Pack

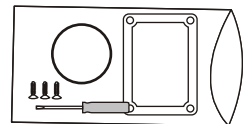

Accessing the Configuration DIP Switches

There are several configuration DIP switches located underneath the dome cover of the camera. Please follow the steps below to safely remove the dome cover. After the configuration switches have been set, follow these steps in reverse order to reinstall the dome cover.

See the following page for configuration details.

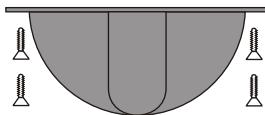
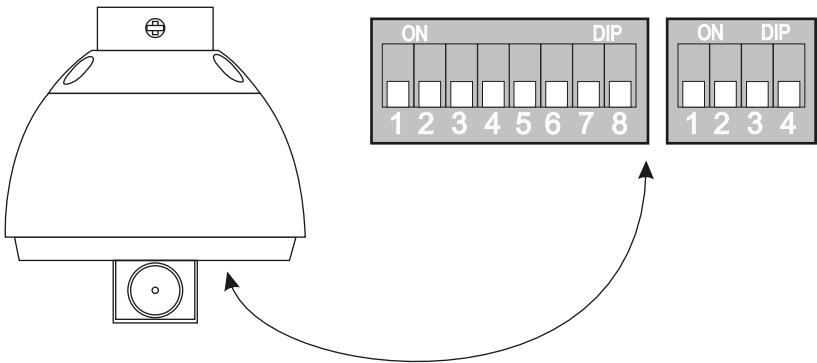

2. To release the inner dome, remove the 4 screws holding it in place.

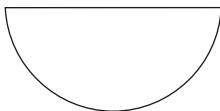

1. Unscrew the clear dome to remove it.

DIP Switch Settings

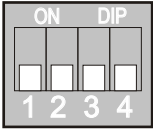

PTZ Protocol Settings...

These DIP switches select the PTZ protocol and baud rate that will be used for communication between the camera and PTZ controller. Follow the table below.

	1	2	3	4
Auto Detect	Off	Off	Off	Off
Pelco-D(2400)	Off	Off	On	Off
Pelco-P(4800)	Off	On	On	On
2400bps	Off	Off	} Baud Rates	
4800bps	Off	On		
9600bps	On	Off		
19200bps	On	On		

Example... This switch configuration will make the camera respond to Pelco-D at 2400bps.

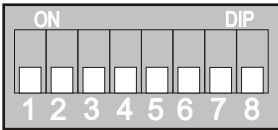
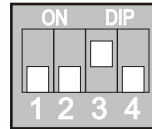

Camera ID Settings... These DIP switches set the camera ID that will allow your PTZ controller to send discrete commands to move this specific camera. You can set the ID anywhere between 0 and 255. See the example below to learn how to set these switches.

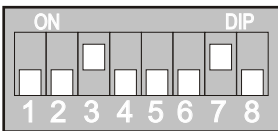

Example... To calculate the camera ID, add up all the values of the switches in the "ON" position.

Switch Value	Switch Position	Camera ID Calculation
128	Off	→ 0
64	On	→ 64
32	Off	→ 0
16	Off	→ 0
8	Off	→ 0
4	On	→ 4
2	Off	→ 0
1	Off	→ 0
		+ 0
		Camera ID = 68

Installation

Note: The installation of the 6154 camera is shown below. The 6144 comes with a different mount, but the installation is otherwise identical.

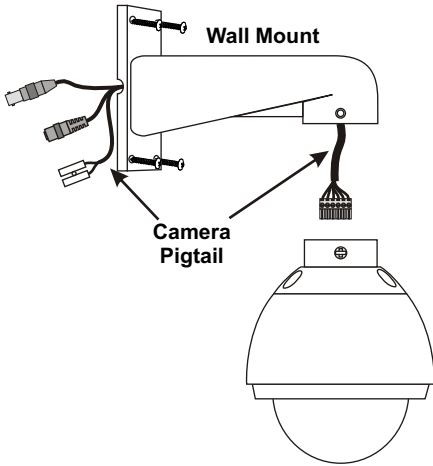

1. Drill a hole for wiring to exit the wall.
2. Feed camera pigtail through the base of the wall mount.
3. Attach mount to wall with screws.
4. Connect camera pigtail to the base of the camera.
5. Secure the camera to the mount using the set screw.

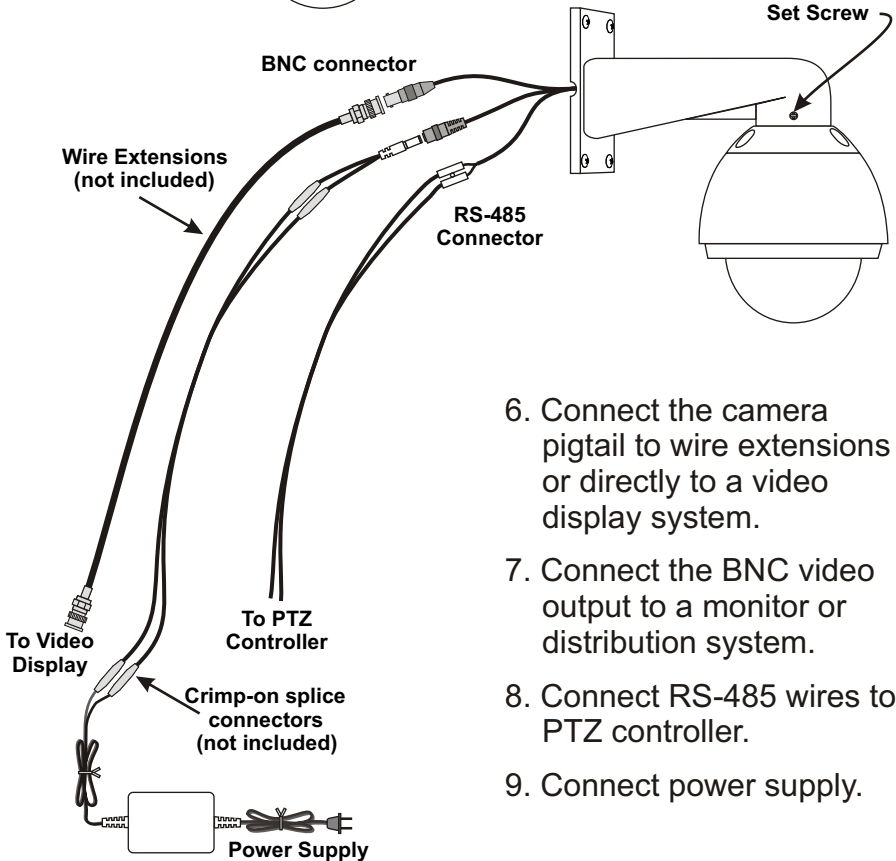

6. Connect the camera pigtail to wire extensions or directly to a video display system.
7. Connect the BNC video output to a monitor or distribution system.
8. Connect RS-485 wires to PTZ controller.
9. Connect power supply.

Trouble Shooting

Problem	Possible Cause	Solution
No motion and no video output	Power supply is disconnected or damaged.	Check power supply. Replace if needed.
Normal Video output but abnormal motion	Power supply voltage is too low.	Make sure to use the correct power supply. Move the power supply closer to the camera.
Have motion control, but no video	Faulty coax connection.	Check with cable tester or verify cable by sending known good video signal through it.
Normal video output, but no motion control	Camera protocol does not match controller.	Check the DIP Switches.

*Specifications

Image Sensor:	1/3" Hi-Res CCD
Picture Elements:	NTSC: 768x494
Resolution:	500 lines
S/N Ratio:	More than 48 dB
Min Illumination:	0.7 Lux @ F1.8
Electronic Shutter:	1/60s - 1/120,000s
Iris Control:	Automatic/Manual
White Balance:	Automatic
Gamma Characteristic:	0.45
Focus:	Auto/Manual/One push
Optical Zoom:	10X, f = 3.8 to 38.00mm
Min. Focal Distance:	1.000mm
Digital Zoom:	Off/On (X2 - X10)
Zoom Speed:	1.67 sec: Wide to Tele
Angle Field of View:	H: 51.2°(wide) - 5.58°(tele) V: 39.3°(wide) - 4.27°(tele)
Sync. System:	Internal
Power Supply:	24VAC, 2Amps
Power Consumption:	38Watts (max with heaters on)
Video Output:	1 Vp-p @ 75 ohms
RS-485 Camera ID:	Selectable: 0-255
Weather Resistance:	6154: IP66 for Outdoor use 6144: Indoor use only
Operating Temp (6144):	-10°C to +45°C (14°F to 113°F)
Operating Temp (6154):	-30°C to +60°C (-22°F to 140°F)
Operating Humidity:	0% to 90% (non-condensing)
Storage Temp:	-20°C to 60°C (-4°F to 140°F)
Storage Humidity:	0% to 95% RH

*Specifications subject to change without notice.



2 Year Limited Warranty

Channel Vision Technology will repair or replace any defect in material or workmanship which occurs during normal use of this product with new or rebuilt parts, free of charge in the USA, for two years from the date of original purchase. This is a no hassle warranty with no mail in warranty card needed. This warranty does not cover damages in shipment, failures caused by other products not supplied by Channel Vision Technology, or failures due to accident, misuse, abuse, or alteration of the equipment. This warranty is extended only to the original purchaser, and a purchase receipt, invoice, or other proof of original purchase date will be required before warranty repairs are provided.

Mail in service can be obtained during the warranty period by calling (800) 840-0288 toll free. A Return Authorization number must be obtained in advance and can be marked on the outside of the shipping carton.

This warranty gives you specific legal rights and you may have other rights (which vary from state to state). If a problem with this product develops during or after the warranty period, please contact Channel Vision Technology, your dealer or any factory-authorized service center.



www.channelvision.com

234 Fischer Avenue, Costa Mesa, California 92626 USA

(714)424-6500 • (800)840-0288 • (714)424-6510 fax

email: techsupport@channelvision.com