

## Installation Instructions and User Guide

### 1. Installation

#### 1.1 Guidelines

**TURN OFF POWER TO THE HEATING SYSTEM AT THE MAIN POWER PANEL TO AVOID ELECTRICAL SHOCK.**

Installation should be carried out by an electrician.

- For a new installation, choose a location about 5 ft. (1.5 m) above the floor.
- The thermostat must be installed facing the heating system and on an inside wall.
- Avoid locations where there are air drafts (top of staircase, air outlet), dead air spots (behind a door), direct sunlight or concealed chimneys or stove pipes.

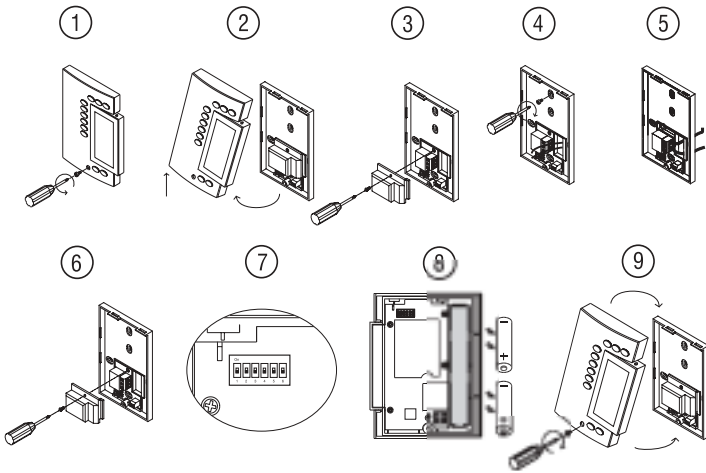

- 1 Remove the screw (captive) holding the base to the control module.
- 2 Lift the lower part of the module to remove it from the base.
- 3 Remove the screw (captive) holding the wire cover and remove the wire cover.
- 4 Pull wires through the base hole and secure the base to the wall (or onto an electrical box for line voltage wiring) using the enclosed wall anchors and screws.
- 5 Wire the base to the heating system (see section 1.2) and connect the remote input, if necessary (see section 1.3).
- 6 Once wiring is complete, re-install the wire cover.
- 7 Use the switches located at the back of the control module to configure your thermostat (see section 1.4) according to your application.
- 8 Install the batteries (see section 1.5).
- 9 Mount the control module on the base and secure using the screw.

### 1.2 Thermostat Wiring

#### NORTH AMERICA

LOW VOLTAGE < 30 V: no polarity

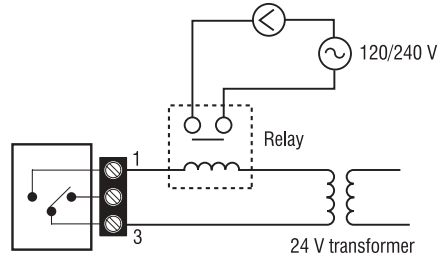

Connection to a circulator through a 24 V relay

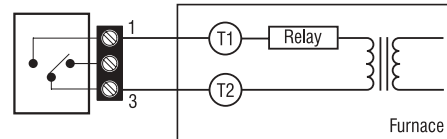

Connection to the thermostat terminals of a furnace

#### LINE VOLTAGE 120 to 240 VAC

Must be installed onto a certified electrical box.

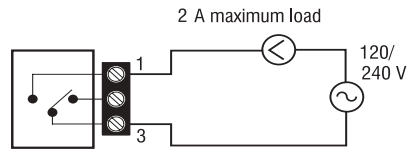

Connection to a circulator (pump) of a water heating system

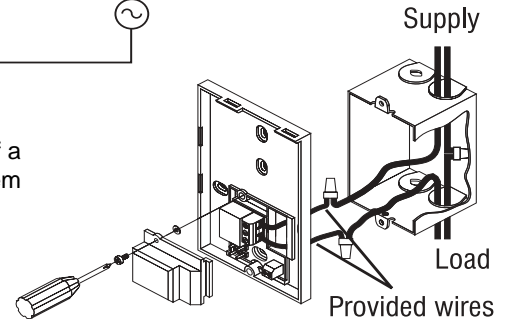

#### EUROPE

For a 2-wire connection: no polarity

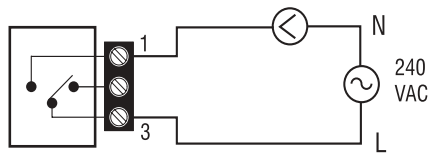

Direct wiring to the circulator

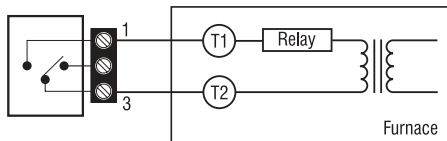

Connection to the thermostat terminals of a furnace

For a 3-wire connection: respect the polarity

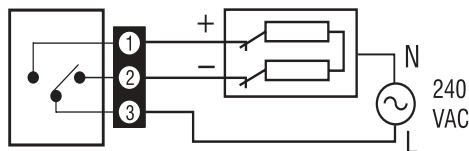

Wiring to a power-operated mixing control valve

### 1.3 Remote Input Wiring

The TH140 is equipped with a remote input which allows connection of a telephone controller (optional Aube CT240), a home automation system or any other remote control system. When a signal is received through this input, the TH140 will automatically switch from normal operating mode to Vacation mode, or vice versa when the signal is removed.

#### 1.3.1 Connection to the CT240

Connect CT240 terminals A and C to TH140 terminals X and C. You must respect the polarity.

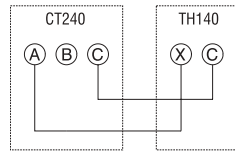

For details on operating the telephone controller, refer to the instruction manual.

#### 1.3.2 Connection to a home automation system

Connect the TH140 to the home automation system as displayed in the wiring diagram.

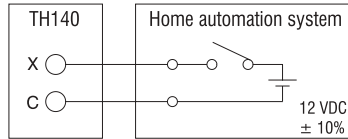

### 1.4 Configure the Thermostat

Before mounting the control module on the base, you may need to modify some of the default settings. The switches are located on the back of the control module. Default settings are highlighted.

Switch	Description	UP	DOWN
1 & 2	Cycles (proportional) Span (conventional)	15 min (proportional) (see 1.4.1)	
		0.5°C (conventional) (see 1.4.2)	
3	Clock display	12H	24H
4	Temperature display <sup>1</sup>	°F	°C
5	Temperature control mode	Proportional (see 1.4.1)	Conventional (see 1.4.2)
6	Pump protection <sup>2</sup>	Deactivate	Activate

- Please note that if you change from °F to °C (or vice versa), your comfort and economy settings will need to be reconfigured as well.
- For hot water installations, it is recommended enabling this option to activate the pump for one minute every 24 hours in order to avoid any seizing.

#### 1.4.1 Proportional Adaptive Mode (switch #5)

This mode analyzes previous cycles to define the length of the upcoming cycle. This control mode guarantees optimal temperature control based on the system's capacity. To extend the life of the system, a minimum On/Off time of 10% of the cycle has been implemented. For example with a 15-minute cycle, the system would not start or stop for less than 1.5 minutes.

Ideal for:

Radiant or convection electrical heating system • Circulator control in a hot water system • Electrical hot air furnace • Hot air, gas or fuel conventional furnace.

Not recommended for:

- Gas or fuel furnace or boiler with a wall chimney having a 30-second or higher combustion gas purging cycle. To figure out the gas purging cycle of your system, count the time between the heating command sent by the thermostat and the moment when the burner actually goes on.
- Multi-zone systems, where several thermostats command a single heating unit.

**Note:** In these last two cases, conventional mode with anticipation is recommended.

### Heating Cycle Selection (switches #1 and #2)

In proportional adaptive mode, the TH140 adapts the control cycles to the system's capacity. Short cycles help eliminate temperature variations, thus increasing user comfort. Since shorter cycles can lead to premature system wear, it is important to select the temperature control cycles appropriate to your heating system. In general, the bigger your heating unit is, the longer the cycles should be.

Select the cycle using switches #1 and #2. We recommend the following options:

Cycles	EUROPE	AMERICA	Position
5 minutes	Not recommended for furnaces	Not recommended for central units	
10 minutes	Gas or electric wall furnace	Radiant or convection electric heating	
15 minutes	Fuel or gas floor furnace, forced air heating	Central heating	
20 minutes	Commercial unit		

#### 1.4.2 Conventional mode with anticipation (switch #5)

If you choose conventional mode with anticipation, it is possible to program a span (temperature variations between ON and OFF orders of your system). This mode is compatible with all heating systems.

#### Programmable Span Selection (switches #1 and #2)

The default temperature span is 0.9°F. For example, if the temperature setpoint is 68°F, the heating system will turn on at 67.1°F and turn off at 68.9°F.

Select the cycle using switches #1 and #2. We recommend the following options:

Span	Hot Water Heating	Forced Air Heating	Position
0.5°F (0.3°C)	Not recommended for furnaces	Not recommended for central units	
0.7°F (0.4°C)	Gas or electric wall furnace	Radiant or convection electric heating <sup>1</sup>	
0.9°F (0.5°C)	Fuel or gas floor furnace	Central heating	
1.1°F (0.6°C)	Commercial unit		

- 240 volt heating with relay (baseboard, convactor, radiant ceiling, etc.)

### 1.5 Install the Batteries

When you first install the batteries, the unit runs a sequence of tests and a complete reset to zero. The screen should display 0:00 MO and the ambient temperature. The current setpoint is 20°C. The ambient temperature could be higher if you are holding the TH140 in your hands. It will return to normal about one hour after installation.

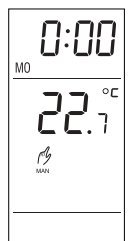

### 1.5.1 Replacing the batteries

The TH140 will display an icon indicating that the batteries must be replaced. This icon will be displayed for 60 days; after this delay, the TH140 will shut down the heating unit.

The time and programming are saved for 15 seconds when replacing the batteries.

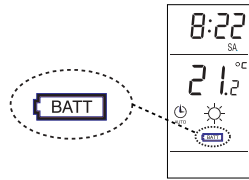

## 2. Basic Configuration

**Note:** You may program the thermostat while holding it in your hands or when it is mounted on the mounting plate.

### 2.1 Set the Time and Day

- 1 Set the time, using the **HOUR** and **MINUTE** buttons.
- 2 Set the day, using the **DAY** button.

### 2.2 Configure the Setpoints

#### 2.2.1 Comfort and Economy

These setpoints are associated to the schedule's programs and are pre-programmed as follows:

Comfort	☀	68°F (20°C)	Programs 1 and 3
Economy	☾	64°F (18°C)	Programs 2 and 4

#### 2.2.2 Vacation

This pre-programmed setpoint is used when the Vacation mode is activated.

Vacation	👛	50°F (10°C)
----------	---	-------------

#### 2.2.3 To Modify a Setpoint

- 1 Set the temperature using ▲▼.
- 2 Press and hold one of the setpoint buttons (☀ or ☾ or 👛) until the icon is displayed on the screen (approx. 3 seconds).
- 3 Press **MANUAL/AUTO** to select the normal operating mode.

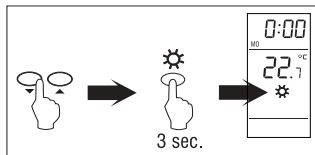

### 2.3 View the Current Setpoint

To view the current setpoint, quickly press **once** one of the arrow buttons ▲▼.

The screen displays the setpoint; the arrow indicates a setpoint.

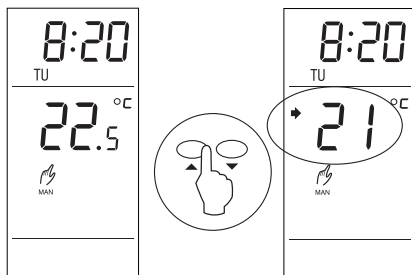

## 3. Select the Operating Mode

The TH140 offers three operating modes:

### 3.1 Automatic ⌚

This mode executes the schedule.

To activate:

- Press **MANUAL/AUTO** until ⌚ is displayed. The program setpoint icon is displayed.



#### 3.1.1 Temporary Bypass

When in Automatic mode, you can temporarily bypass the current program setpoint until the beginning of the next program. To bypass:

- Set the desired temperature ▲▼ OR quickly press ☀ or ☾ to use a pre-defined setpoint.

### 3.2 Manual 🖐

This mode allows you to maintain a constant temperature. To activate this mode:

- Press **MANUAL/AUTO** until 🖐 is displayed.
- Set temperature ▲▼ OR quickly press ☀ or ☾ to use a pre-defined setpoint.

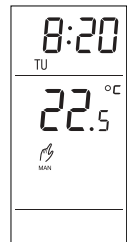

### 3.3 Vacation 👛

Maintains a specific temperature when away for a prolonged absence (e.g. vacation).

- From the TH140, quickly press 👛 to activate.
- Can also be activated remotely (CT240, home automation system or any other system) if the remote input is connected to one of these systems.

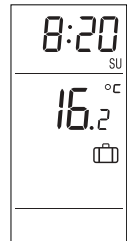

**Note:** When the Vacation mode is activated remotely, it can only be deactivated remotely.

**Note:** For details on how to activate the Vacation mode using a telephone, refer to the CT240 Instruction Manual.

## 4. Program Your Schedule

The TH140 allows four setting changes for each day of the week. There are no pre-set programs. The programs can be tailored to fit your life style.

For each day, enter the time at which you wake up (PROG 1), the time you leave for work (PROG 2), the time you return home (PROG 3) and the time you go to bed (PROG 4):

Programs	Associated Setpoint	Time
PROG 1	☀ (Comfort)	Wake-up
PROG 2	☾ (Economy)	Leave home
PROG 3	☀ (Comfort)	Return home
PROG 4	☾ (Economy)	Night

**Note:** For temperature increases (PROG 1 and 3), allow at least 15 minutes per °C. For example, if you have lowered the temperature by 3°C during the night and you wake up at 7 a.m., change the setting at 6:15 a.m.

## 4.1 Set or Modify the Programs

- After 60 seconds of inactivity, the thermostat will automatically exit programming mode.
- It is sometimes faster to program the same schedule for the entire week and then modify the exception days.

- ➊ Press **PROGRAM**. The screen displays MO and PROG 1.
- ➋ Press **DAY** to select the day (hold for 3 seconds to select all days of the week).
- ➌ Press **HOURL** and **MIN** to set the start time.  
To clear an entry, press **CLEAR**, the time zone displays --:-- when the program is inactive.
- ➍ Press **PROGRAM** to select the program number (2, 3 or 4).
- ➎ Repeat steps 3 and 4 for remaining programs.
- ➏ Press **MANUAL/AUTO** to exit.

### 4.1.1 Programming Example

☀ Comfort (programs 1 and 3):

- Monday to Friday between 6:00 a.m. and 8:30 a.m. and between 4:00 p.m. and 11:00 p.m.
- Saturday and Sunday between 6:00 a.m. and 11:00 p.m.

☾ Economy (programs 2 and 4):

- Monday to Friday between 8:30 a.m. and 4:00 p.m. and between 11:00 p.m. and 6:00 a.m.
- Saturday and Sunday between 11:00 p.m. and 6:00 a.m.

PROG	MON	TUE	WED	THU	FRI	SAT	SUN
1	☀	6:00	6:00	6:00	6:00	6:00	6:00
2	☾	8:30	8:30	8:30	8:30	--:--	--:--
3	☀	PM 4:00	PM 4:00	PM 4:00	PM 4:00	--:--	--:--
4	☾	PM 11:00	PM 11:00	PM 11:00	PM 11:00	PM 11:00	PM 11:00

To program this schedule:

- ➊ Press **PROGRAM**. The screen displays MO and PROG 1.
- ➋ Press and hold **DAY** for 3 seconds to select all days of the week (MOTUWETHFRSASU).
- ➌ Set the time (6:00) for the first program (PROG 1) using the **HOURL** and **MIN** buttons.
- ➍ Press **PROGRAM** to select PROG 2. Set the time (8:30) using the **HOURL** and **MIN** buttons.
- ➎ Press **PROGRAM** to select PROG 3. Set the time (4:00 p.m.) using the **HOURL** and **MIN** buttons.
- ➏ Press **PROGRAM** to select PROG 4. Set the time (11:00 p.m.) using the **HOURL** and **MIN** buttons.
- ➐ Press **MANUAL/AUTO** to exit

To erase programs 2 and 3 for Saturday and Sunday:

- ➊ Press **PROGRAM** to access programming mode.
- ➋ Press **PROGRAM** until PROG 2 is selected.
- ➌ Press **DAY** to select SAturday (SA).
- ➍ Press **CLEAR** to erase the time (--:--).
- ➎ Press **DAY** to select SUnDay (SU).
- ➏ Press **CLEAR** to erase the time (--:--).
- ➐ Repeat steps 2 to 5 for PROG 3.
- ➑ Press **MANUAL/AUTO** to exit.

## 5. Technical Specifications

Model: TH140-28

Power supply: 2 AA or LR6 alkaline batteries 1.5 V

Max. resistive load: 5 A @ 240 VAC / 5 A @ 30 VDC

Max. inductive load: 2 A @ 240 VAC / 2 A @ 30 VDC (P.F. = 0.4)

Remote input: 12 VDC, ± 10%, 2.5 mA

Certifications: CE, c UL us

Control device: Electronic

Automatic action: Type 1 B

Number of programs: 4 programs / day, total of 28 programs

Storage temperature: -4°F to 122°F (-20°C to 50°C)

Operating temperature: 32°F to 122°F (0°C to 50°C), 95% R.H.

Temperature setting range: 40°F to 85°F (5°C to 30°C)

Temperature display resolution: 0.1 degree

Temperature reading accuracy: ± 0.9°F (± 0.5°C)

Software: Class A

Protection class: II

Protection degree: IP 40

The terminals are designed to handle a cross-section of wire measuring up to 2.5 mm<sup>2</sup> (14 AWG).

## 6. Warranty and Service

AUBE TECHNOLOGIES INC. TWO (2) YEAR LIMITED WARRANTY

This product is guaranteed against workmanship defects for a two-year period following the initial date of purchase. During this period, AUBE Technologies Inc. will repair or replace, at our option and without charge, any defective product which has been used under normal conditions. The warranty does not cover delivery costs and does not apply to products poorly installed or randomly damaged following installation. This warranty cancels and replaces any other manufacturer's express or implied warranty as well as any other company commitment. AUBE Technologies Inc. cannot be held liable for related or random damages following the installation of this product. The defective product as well as the purchase invoice must be returned to the place of purchase or mailed, prepaid and insured, to the nearest address.

If you have any questions concerning the installation or programming of the TH140 programmable thermostat, contact our technical support team at:



705 Montrichard  
Saint-Jean-sur-Richelieu  
(Québec) Canada J2X 5K8  
Tel. : (450) 358-4600  
1-800-831-AUBE  
Fax : (450) 358-4650  
service@aubetech.com



10 rue Ampère  
95500 Gonesse  
France  
33 (0) 1 34 07 99 00  
33 (0) 1 34 07 99 19  
advaube@comintes.com

For more information on our products, visit us at  
[www.aubetech.com](http://www.aubetech.com)